



Linear Wall Washer







ITEM
B6JD0656

LIGHT SOURCE
6×1W

LENS
B38

SELECTED DEGREE(°)Ø1/2
30°(B38/30°)

LENGTH(MM)
250

INPUT VOLTAGE(V)
DC 24 120 240

OPERATING CURRENT(MA)
DC 24=3.5 120=50 240=30

CONSUMPTION(W)
DC 24=7.3 120=6 240=6.5

LUMINANCE(LM)
low voltage: CW=410 WW=350
high voltage: CW=540 WW=432

IK
02

(low voltage)

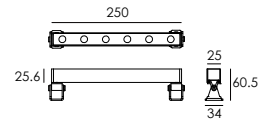

(high voltage)

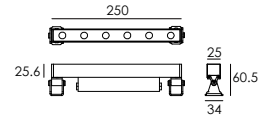

ITEM
B6JD1256

LIGHT SOURCE
12×1W

LENS
B38

SELECTED DEGREE(°)Ø1/2
30°(B38/30°)

LENGTH(MM)
500

INPUT VOLTAGE(V)
DC 24 120 240

OPERATING CURRENT(MA)
DC 24=610 120=130 240=65

CONSUMPTION(W)
DC 24=14.5 120=15.0 240=15.0

LUMINANCE(LM)
low voltage: CW=950 WW=900
high voltage: CW=1080 WW=864

IK
02

(low voltage)

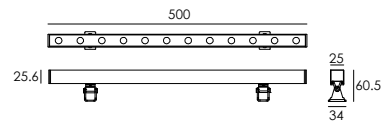

(high voltage)

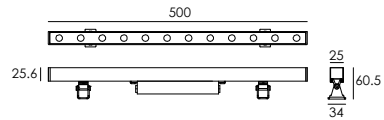

ITEM
B6JD2456

LIGHT SOURCE
24×1W

LENS
B38

SELECTED DEGREE(°)Ø1/2
30°(B38/30°)

LENGTH(MM)
1000

INPUT VOLTAGE(V)
DC 24 120 240

OPERATING CURRENT(MA)
DC 24=1220 120=255 240=135

CONSUMPTION(W)
DC 24=29 120=30.8 240=31.5

LUMINANCE(LM)
low voltage: CW=1660 WW=1413
high voltage: CW=2140 WW=1976

IK
02

(low voltage)

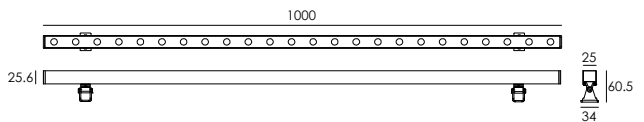

(high voltage)

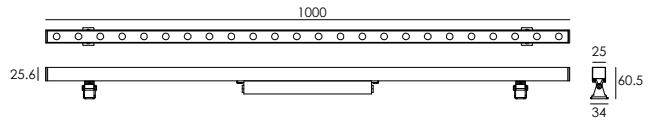

WATER PROOF SOLUTION

(low voltage)

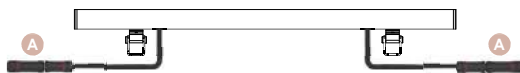

A IP67 Jifty quick plug/socket connector(Included)
A IP-67 connector is an assembly and ensures that water vapor will not enter into luminaires directly.

(high voltage)

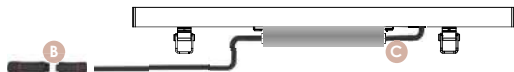

B IP67 Jifty quick plug/socket connector(Option)
A IP-67 connector is as an optional assembly and ensures that water vapor will not enter into luminaires directly.

C High voltage driver IP65

ANTI GLARE LOUVER(Optional)

APPLICATION

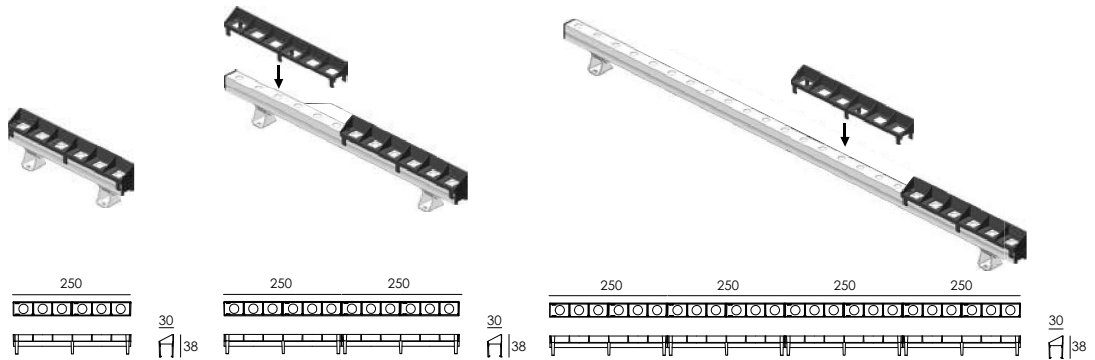

- HOUSING** Extruded aluminum anodized finishing
- BRACKET** Aluminum anodized finishing
- LIGHT WINDOW GASKET** Tempered glass, T=2mm
Glass and housing are silicone sealed
- LENS** OPTICS lens efficiency ≥ 85%
- LED** Single color ORSAM LED
- OPERATING TEMPERATURE** -20°C ~ 40°C
- POWER CABLE** Outside of luminaire
H03VV-F 2×0.75mm², L=0.25m(12V/24V)
H05RN-F 3×1.0mm², L=0.5m(120V/240V)
- DIMMING SUPPORT** Triac PWM Available
1-10V Dali Customized

OPTICS

Referenced Degree(°)Θ1/2



- B38
- 30°
- 40°
- 50°
- 60°
- 25°×50°

CONNECTION

LOW VOLTAGE INPUT (DC 24) POWER CABLE TYPE

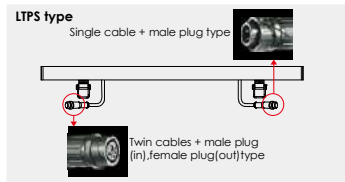

Low voltage input default: LTPS type power cable with conducted input and output, waterproof socket connector are included.



HIGH VOLTAGE INPUT (100V-240V) POWER CALBE WIRING TYPE

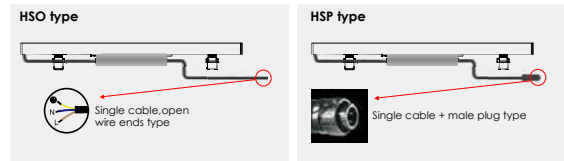

High voltage input default: HSO type power cable, waterproof socket connector are not included(optional).

PHOTOMETRIC(Non anti glare louver)

