

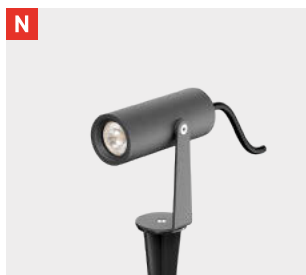

SKIP



MORE INFO >>

		P	CCT	BEAM	I	Flux	LOR
SKIP	A497-01 - 10- GT OX	5,5W	2700K	19°	500mA	620 lm	87%
	A497-01 - 11- GT OX	5,5W	3000K	19°	500mA	660 lm	87%
	A497-01 - 20- GT OX	5,5W	2700K	29°	500mA	620 lm	91%
	A497-01 - 21- GT OX	5,5W	3000K	29°	500mA	660 lm	91%
	A497-01 - 30- GT OX	5,5W	2700K	35°	500mA	620 lm	89%
	A497-01 - 31- GT OX	5,5W	3000K	35°	500mA	660 lm	89%



220 V~ | IP65 | CRI>90 | L90B10 >108.000h

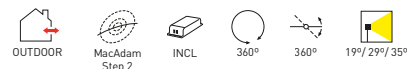

		P	CCT	BEAM	I	Flux	LOR
SKIP	A497-02 - 10- GT OX	5,5W	2700K	19°	500mA	620 lm	87%
	A497-02 - 11- GT OX	5,5W	3000K	19°	500mA	660 lm	87%
	A497-02 - 20- GT OX	5,5W	2700K	29°	500mA	620 lm	91%
	A497-02 - 21- GT OX	5,5W	3000K	29°	500mA	660 lm	91%
	A497-02 - 30- GT OX	5,5W	2700K	35°	500mA	620 lm	89%
	A497-02 - 31- GT OX	5,5W	3000K	35°	500mA	660 lm	89%



48 V | IP65 | CRI>90 | L90B10 >108.000h

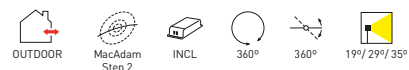

		P	V
CONSTANT VOLTAGE LED POWER SUPPLY	0434-01-62	150W	48V

220 V~ | IP20 | DRIVER MUST BE PLACED ON REMOTE

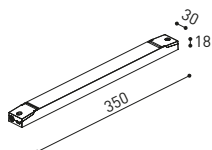

DROP VOLTAGE TABLE

POWER (W)	CABLE SECTION (mm²)	CABLE LENGTH (m)			
		<25	<50	<75	<100
150	0,75	√	√	X	X
	1,0	√	√	√	X
	1,5	√	√	√	√

OPTIONAL ACCESSORIES

Connector IP67 No DIM 0434-01-81- | N |

Connector IP67 No DIM T-Shape 0434-01-82- | N |

For cable Ø4,5-7,5mm, section ≤1,5mm²

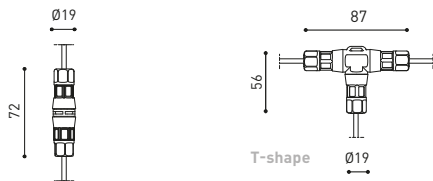

Connector IP67 DIM DALI 0434-01-83- | N |

Connector IP67 DIM DALI T-Shape 0434-01-84- | N |

For cable Ø5,5-7,5mm, section ≤1,0mm²

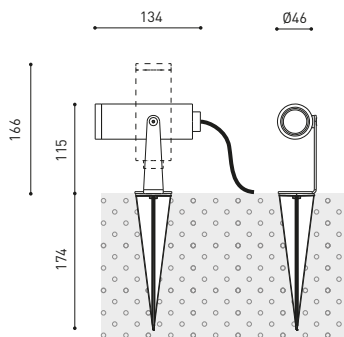
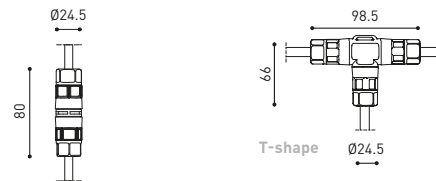

SKIP Anti-glare Screen A497-00 - 00- | GT | OX |

AFFECTS THE LIGHTING PARAMETERS



COLOUR | GT ■ | OX ■ |

MATERIAL | AL | GL-TRANS | PC |

RAL ⓘ >> 312

OTHER CCT PLEASE CONSULT

Ⓜ >> 288